

CAT5 VGA & Data Extender

ITEM NO.: VD02

VD02 are designed for VGA +RS232 data signal over cost effective CAT5 cable to instead of VGA and Data cable. Used in pairs, the VGA & Data Extender is used in home or commercial applications as a smart, fast and cost-effective, eliminates costly and bulky VGA and DATA cable, allowing users can broadcast their video image or control a projector or any other RS-232 device at a remote location. Ideal for sending video images to a projector and controlling it from you desk. Perfect for touch screen or auto control equipment application.

VD02 CAT5 VGA & Data Long Range Extender

Features:

- **Send VGA and RS232 Data over one CAT5 UTP cable to instead of VGA cable and data cable.**
- Dual output at transmitter: 1 VGA loop output for local, plus 1 CAT5 RJ45 output for remote side.
- Supports up to 1600x1200 @85Hz
- **Long range transmission up to 300 meters (Max.)**
- Each set including transmitter and receiver.
- Application for sending Video images to a projector and controlling it from your desk

Installation View:

VD02

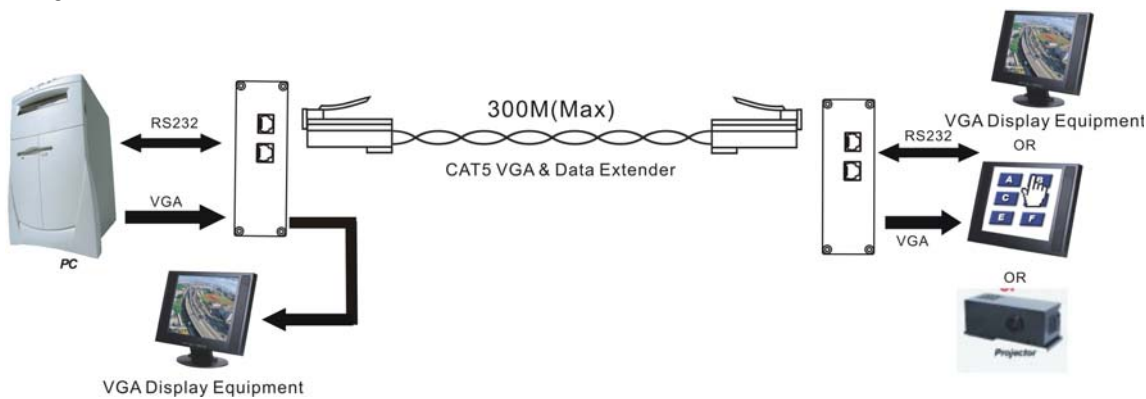

DATA (RS232)

VD02T

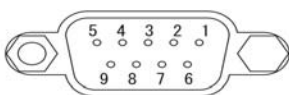

RS232 IN

VD02R

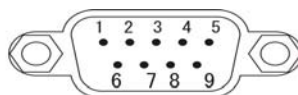

RS232OUT

Panel View:

VD02T

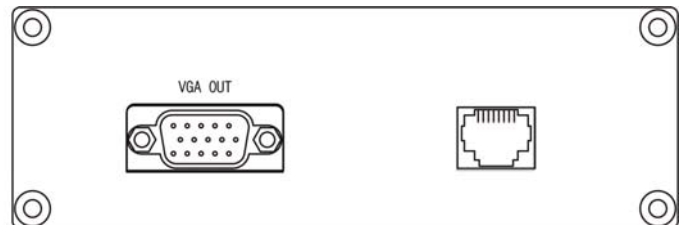
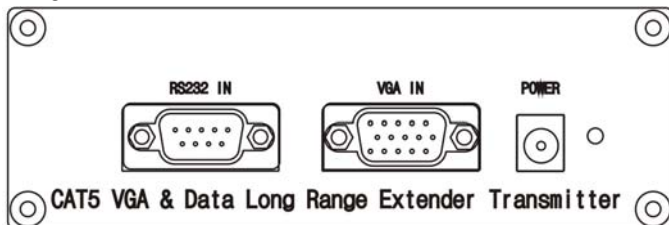

VD02R

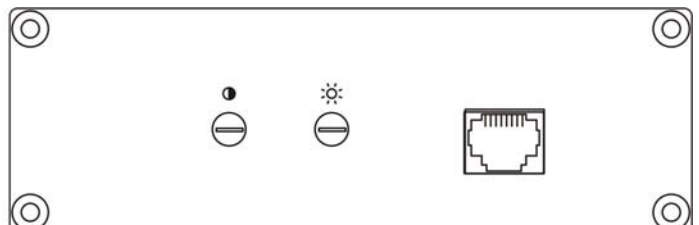
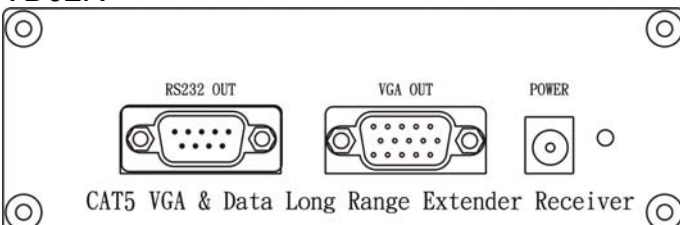

Specification:

ITEM NO.	VD02
Support Resolution	Up to 1600 x 1200 @ 85 Hz
Transmission Distance	Up to 1000 ft. (300 m)
Video Amplifier Bandwidth	150MHz
Input Signals	RGB Analog (75Ω, 0.7Vp-p)+ DATA
	Sync Signal H/V Separated (TTL)
	RS232 Data DB9 connector
Horizontal Frequency Range	30-95KHz
Vertical Frequency Range	50-180Hz
VGA Connector	15-pin Mini D-Sub (High Density)
Link Connector	RJ-45
Power Supply	2 x 5V DC 1000mA (External)
Power Consumption	VD02T 150mA (Max), VD02R 250mA (Max)
CABLE FOR RJ-45	CAT 5 unshielded Twisted Pair Cable (UTP) x 1
Temperature	Operation: 0 to 55°C, Storage: -20 TO 85°C, Humidity: up to 95%
Dimensions W x H x D mm	VD02-T: 133*76*44 , VD02R: 133*72.5*44
Weight g	300

Installation Tips:

1. Due to the inside of CAT5 cable that the pairs of wires are twisted at different rates, AND the different quality on cable itself and installation that will cause different signal arrival time at each pair. If there are big different at arrival time, that will cause RGB skew status. This is seen on the monitor as separation, or lack of convergence in colors. Normally it happens on long CAT 5 cable runs.

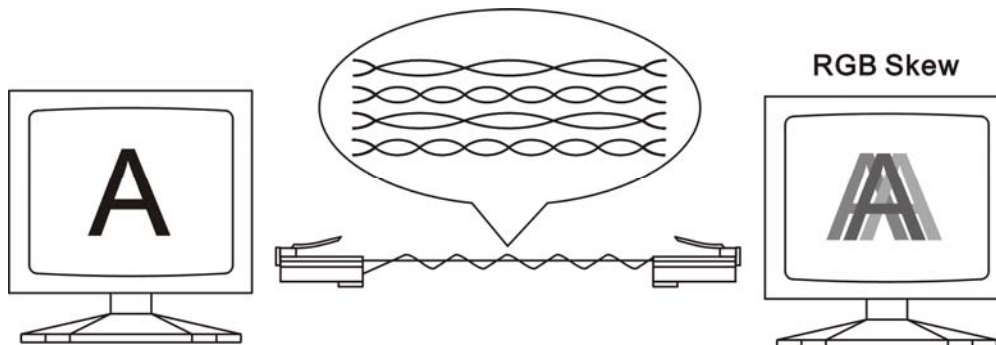

2. Recommend to use following cabling way to reduce skew status, to add special made "skew immunized adaptor", 2 pieces included at the package.

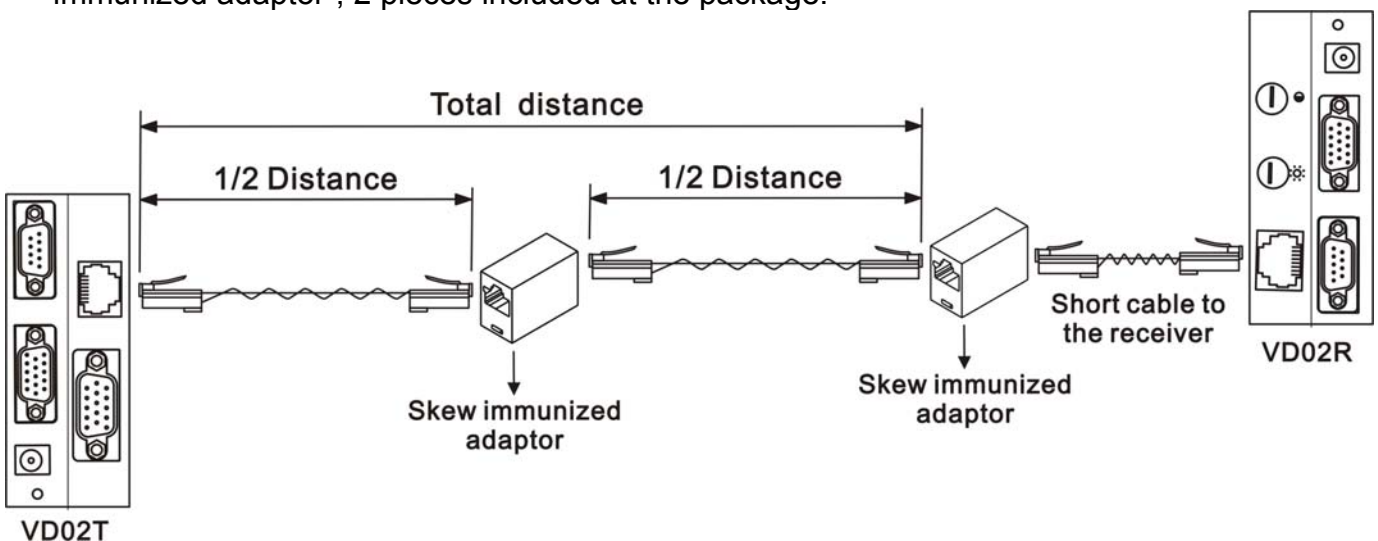

CAUTION: to avoid display equipment damaged, be sure to make correct cable connection and power for both VD02T before connecting VD02R